

付钱拉

API架构演进

中小微企业微服务化



促进软件开发领域知识与创新的传播



关注InfoQ官方信息
及时获取QCon软件开发者
大会演讲视频信息



[北京站] 2016年12月2日-3日
咨询热线: 010-89880682



[北京站] 2017年4月16日-18日
咨询热线: 010-64738142



史晓慕



互联网化 金融云

聚合支付 线下扫码

鉴权服务 资金管理

银行流水 征信报告

余额增值 理财超市

业务特点

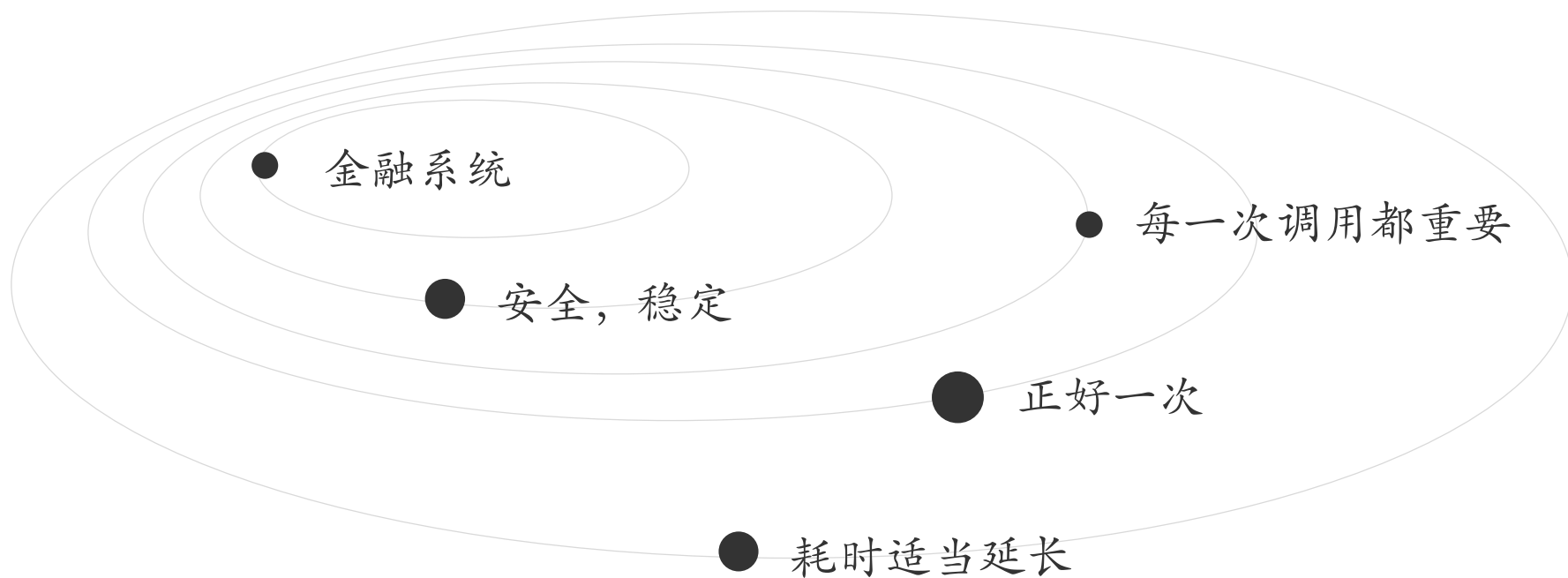

适用范围

简单易用小中规模

处在技术债的积累期

开发团队不过百

硬件规模不过百

服务调用不过亿

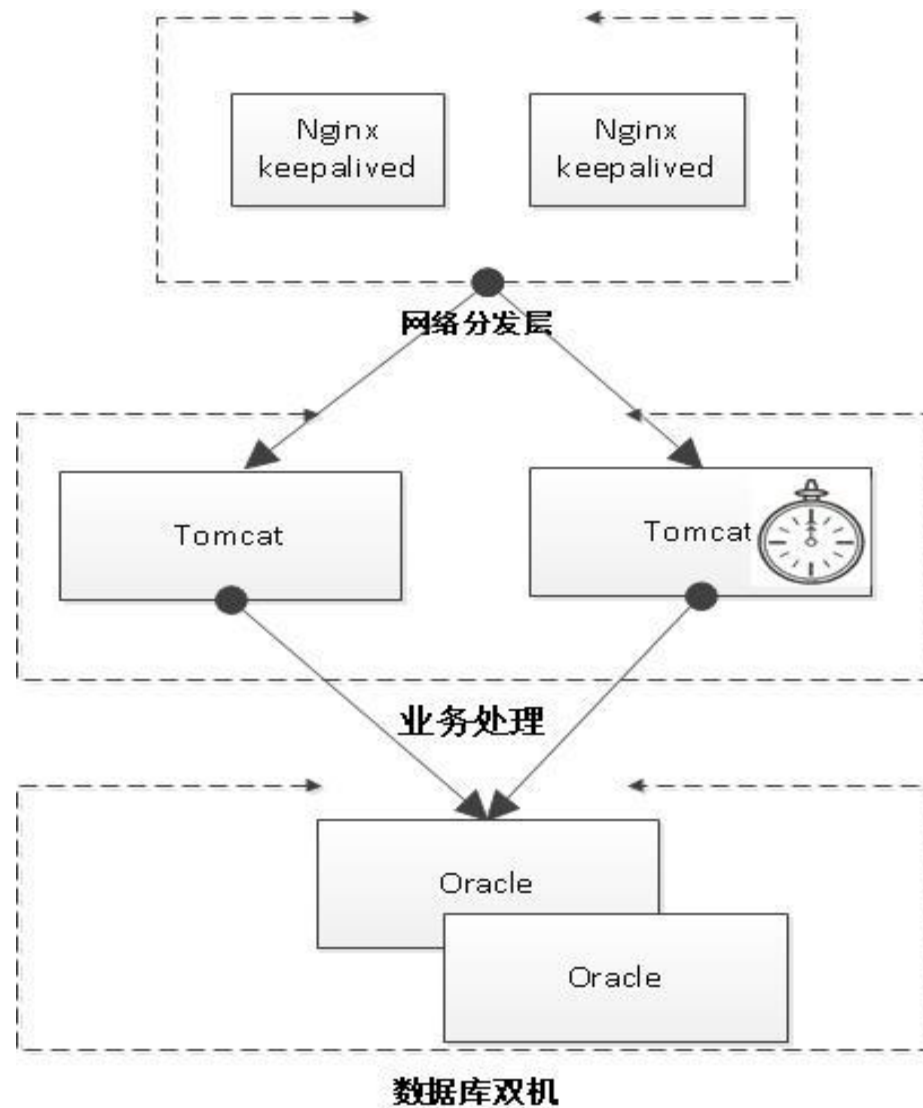

业务发展V2.0

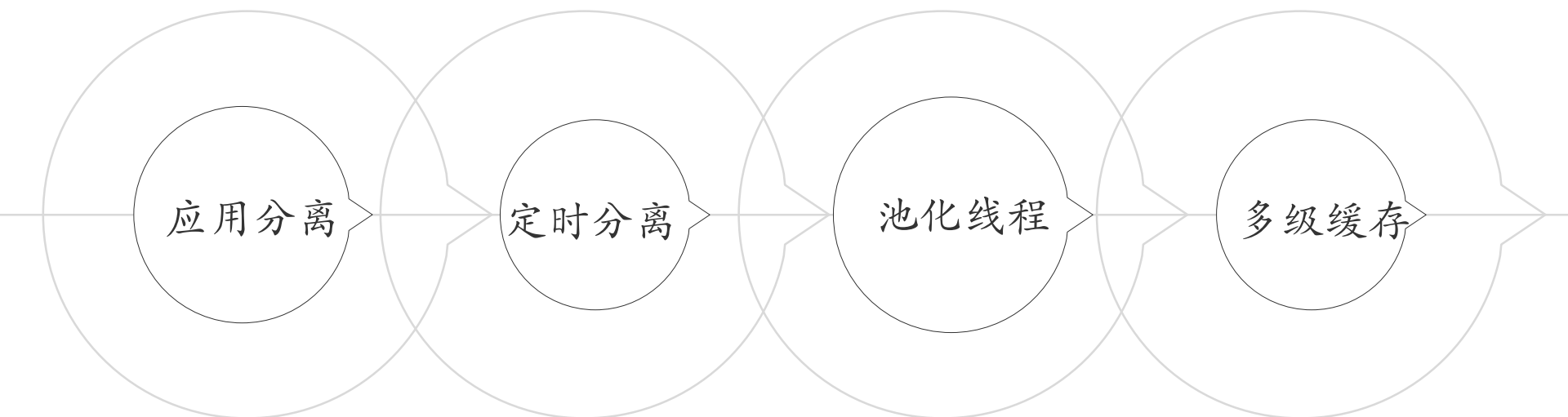

业务发展V2.0

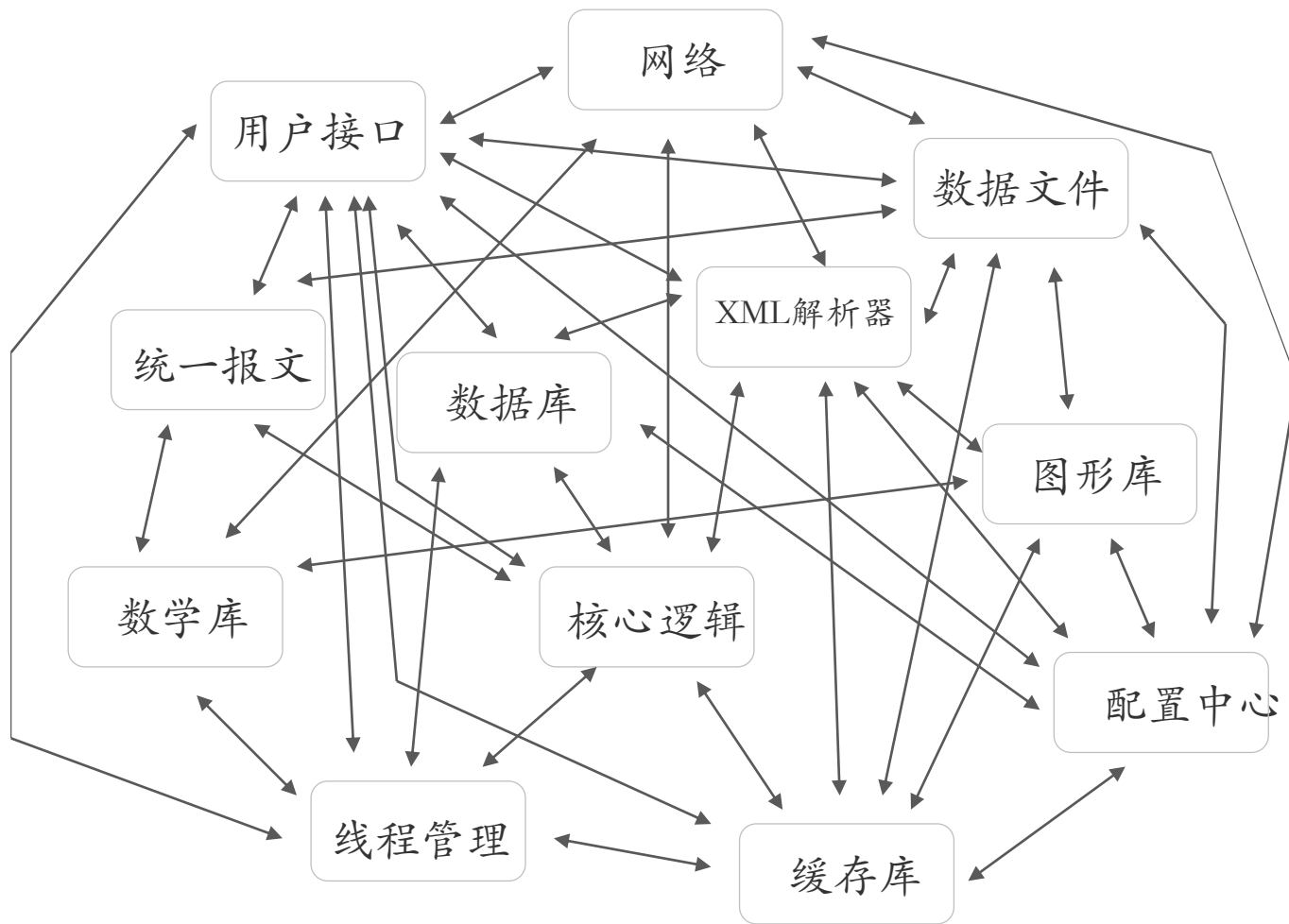

业务的理解和抽象不足

1

2

团队协作不默契

?

不会挑重点

3

4

开源组件多和乱

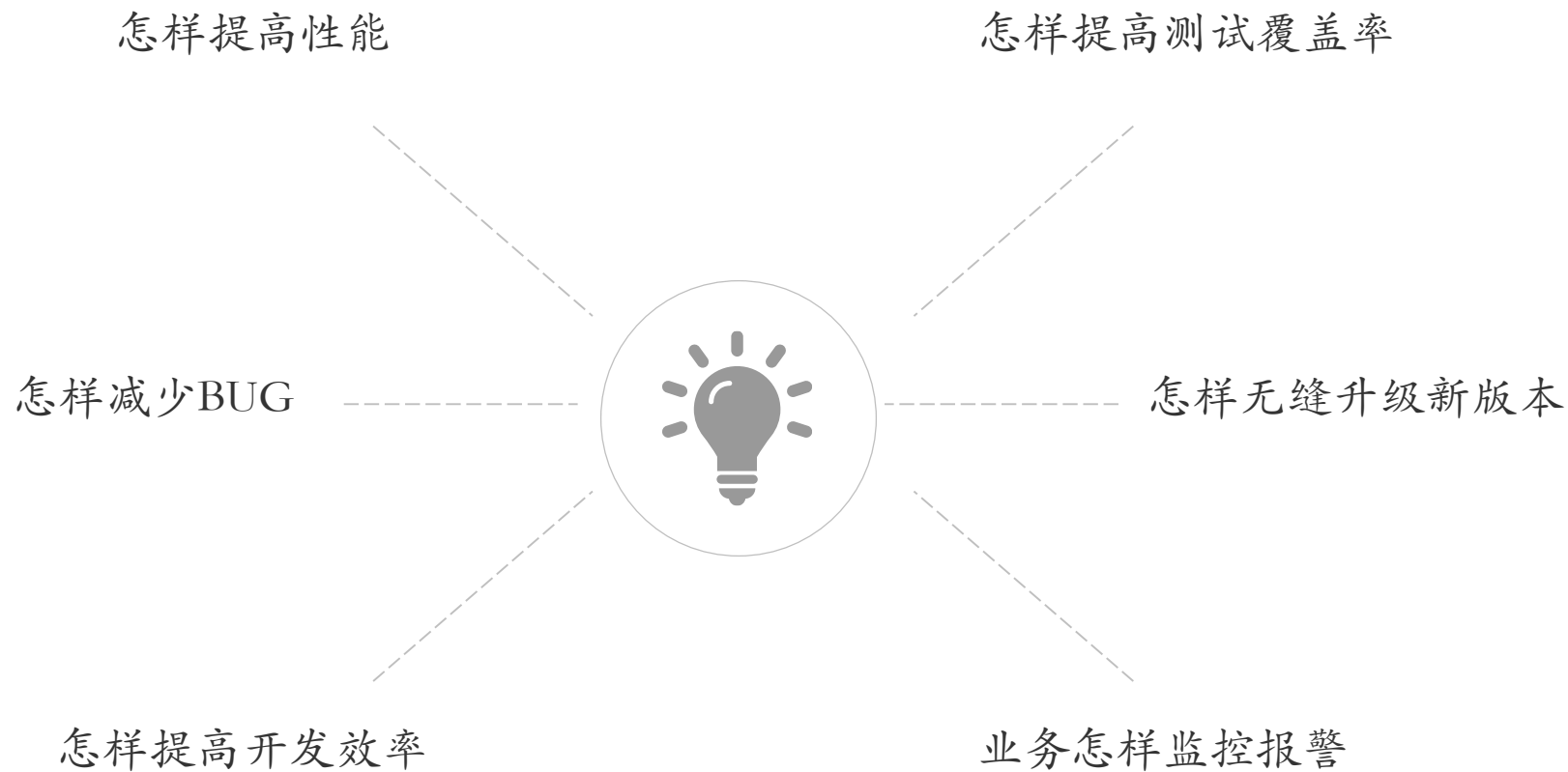

1+1

++1

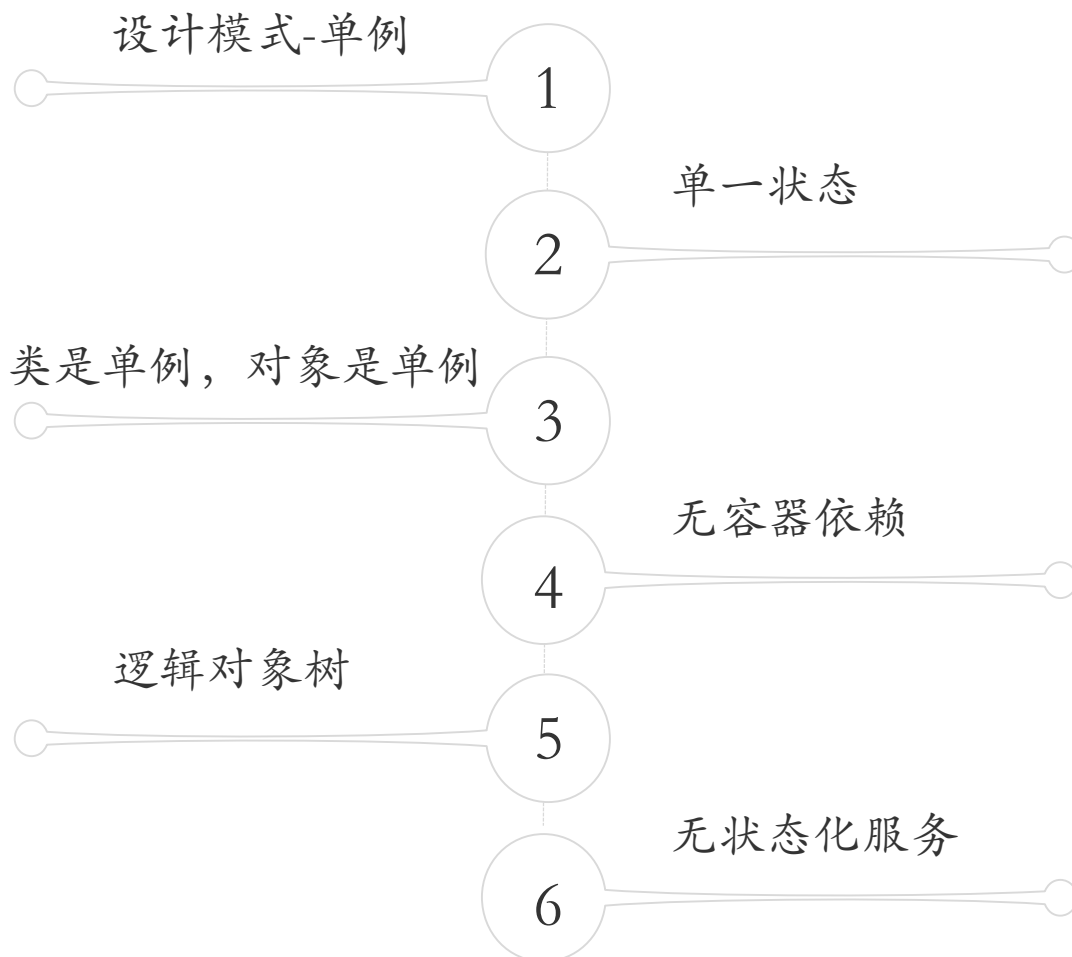

状态即版本

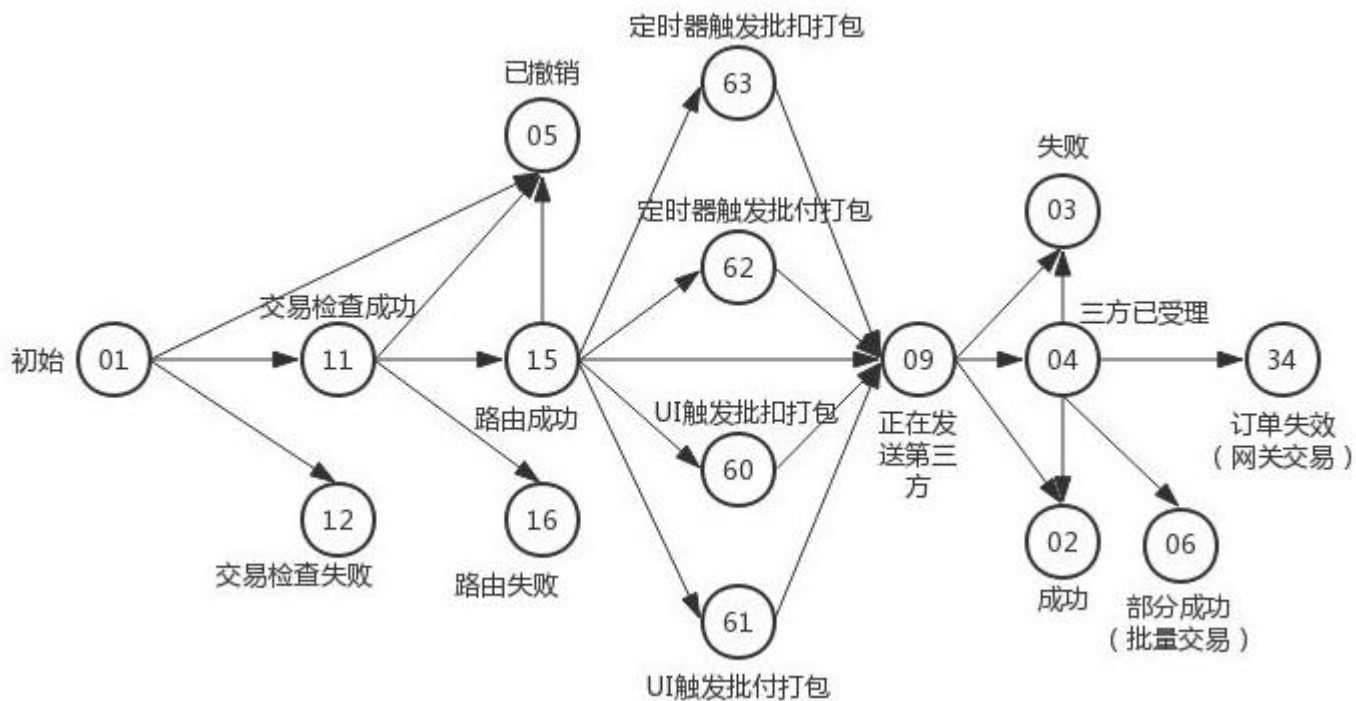

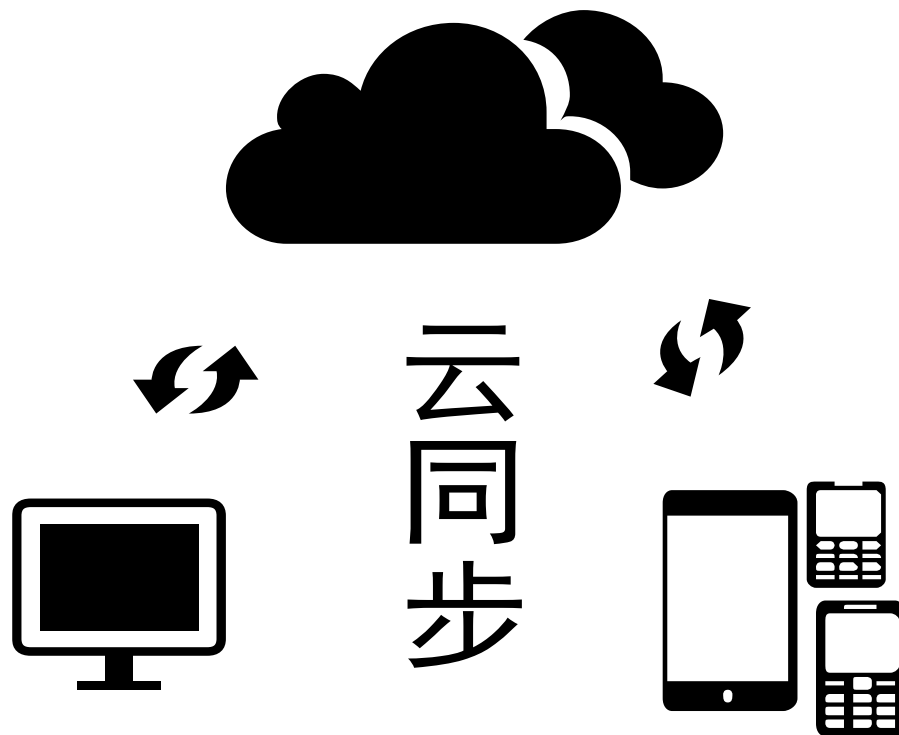

状态新增，处处同步



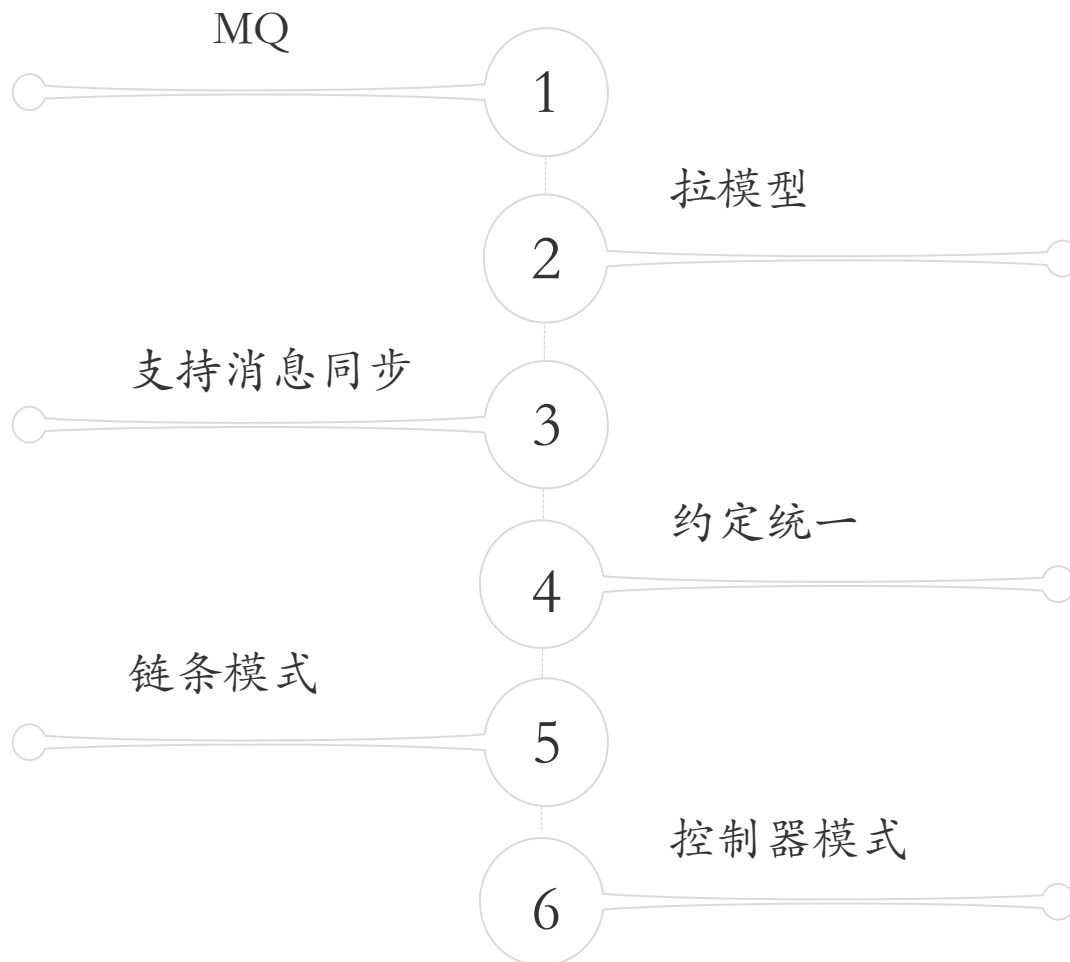

服务化V3.0

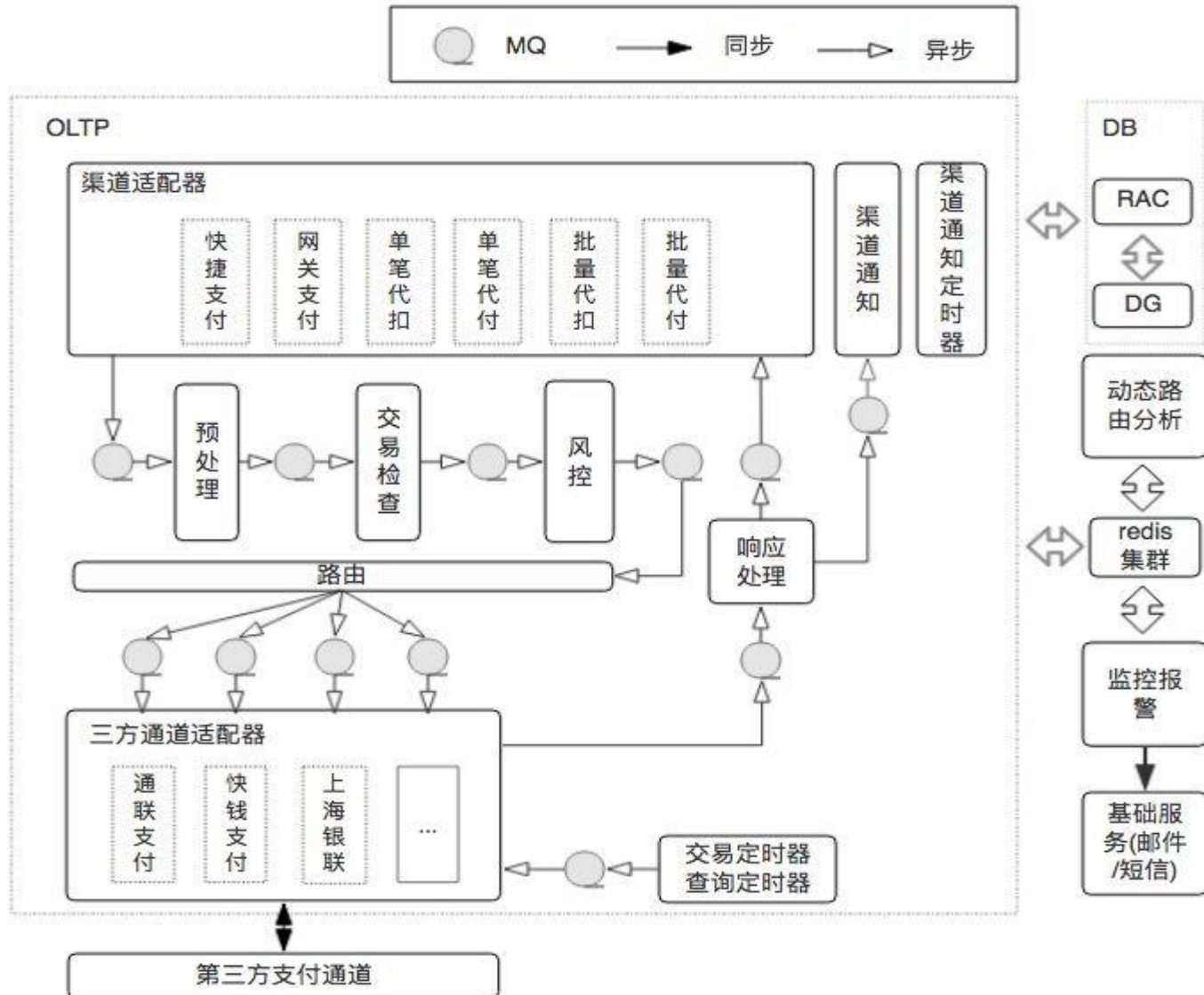

业务发展V3.0

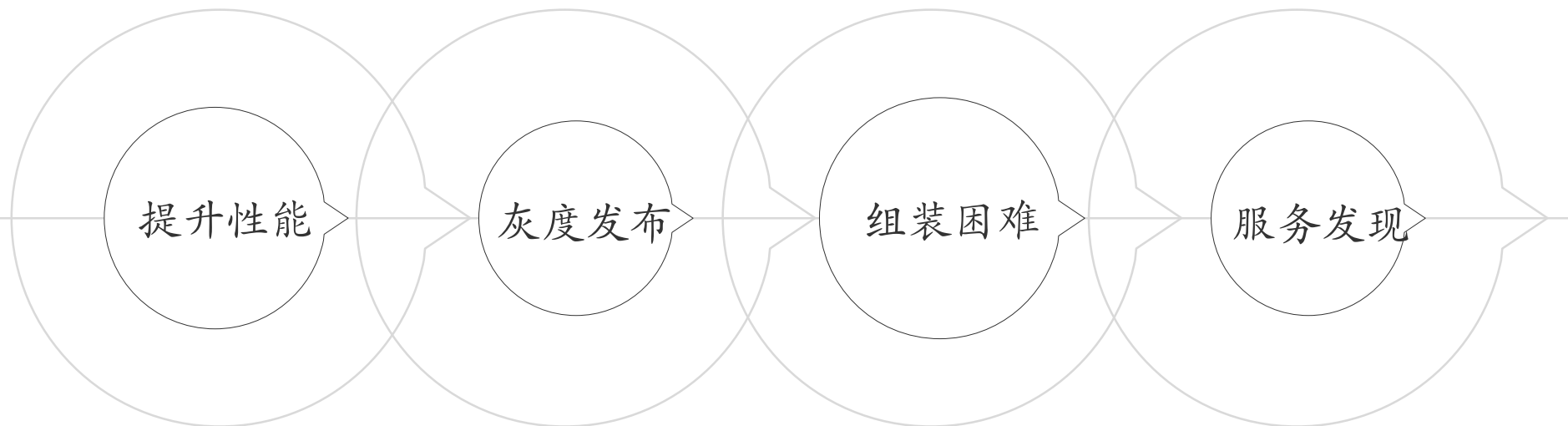

服务化V4.0

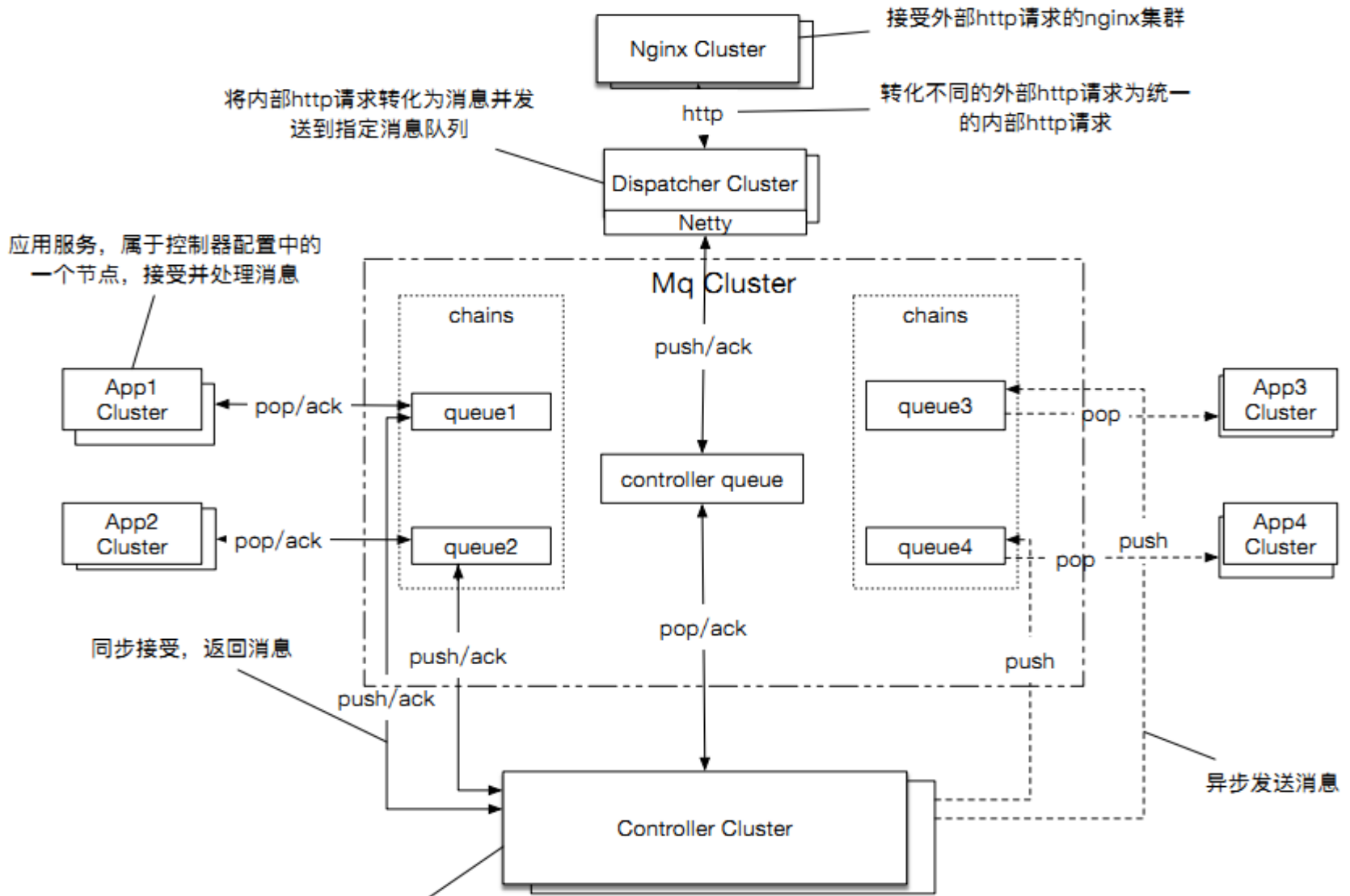

服务编排

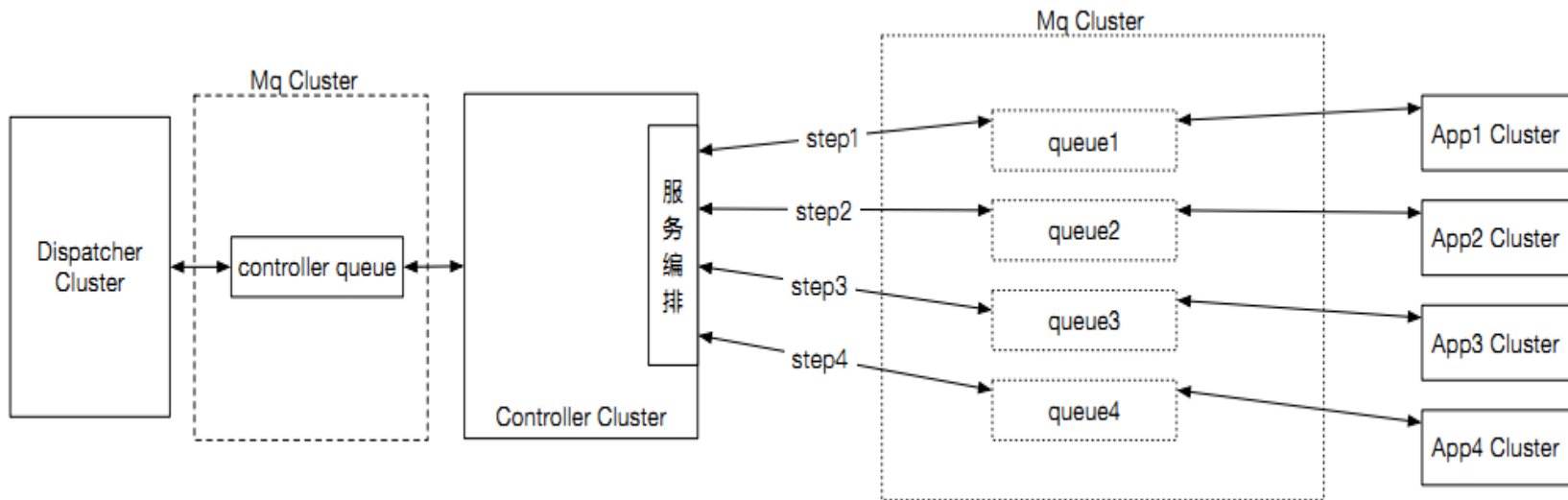

```
<catalog id="testtrycatch" desc="测试try">
  <chain id="testTryChain">
    <tryBlock desc="测试try">
      <publish queueName="parametersCheck" desc="参数检查" />
      <catchBlock desc="捕获所有异常">
        <publish queueName="excephandle" desc="异常处理" />
      </catchBlock>
      <finallyBlock desc="测试最终处理">
        <publish queueName="finallyhandle" desc="最终处理" />
      </finallyBlock>
    </tryBlock>
    <condition cond="DATASIZE > '0'" class="com.creditease.ns.control">
      <publish queueName="fetchdata" desc="分拆数据"/>
      <remotecall queueName="batch_controller" serviceName="batchT">
    </condition>
    <publish queueName="fetchdata" desc="分拆数据"/>
  </chain>
</catalog>
```

调度与批处理

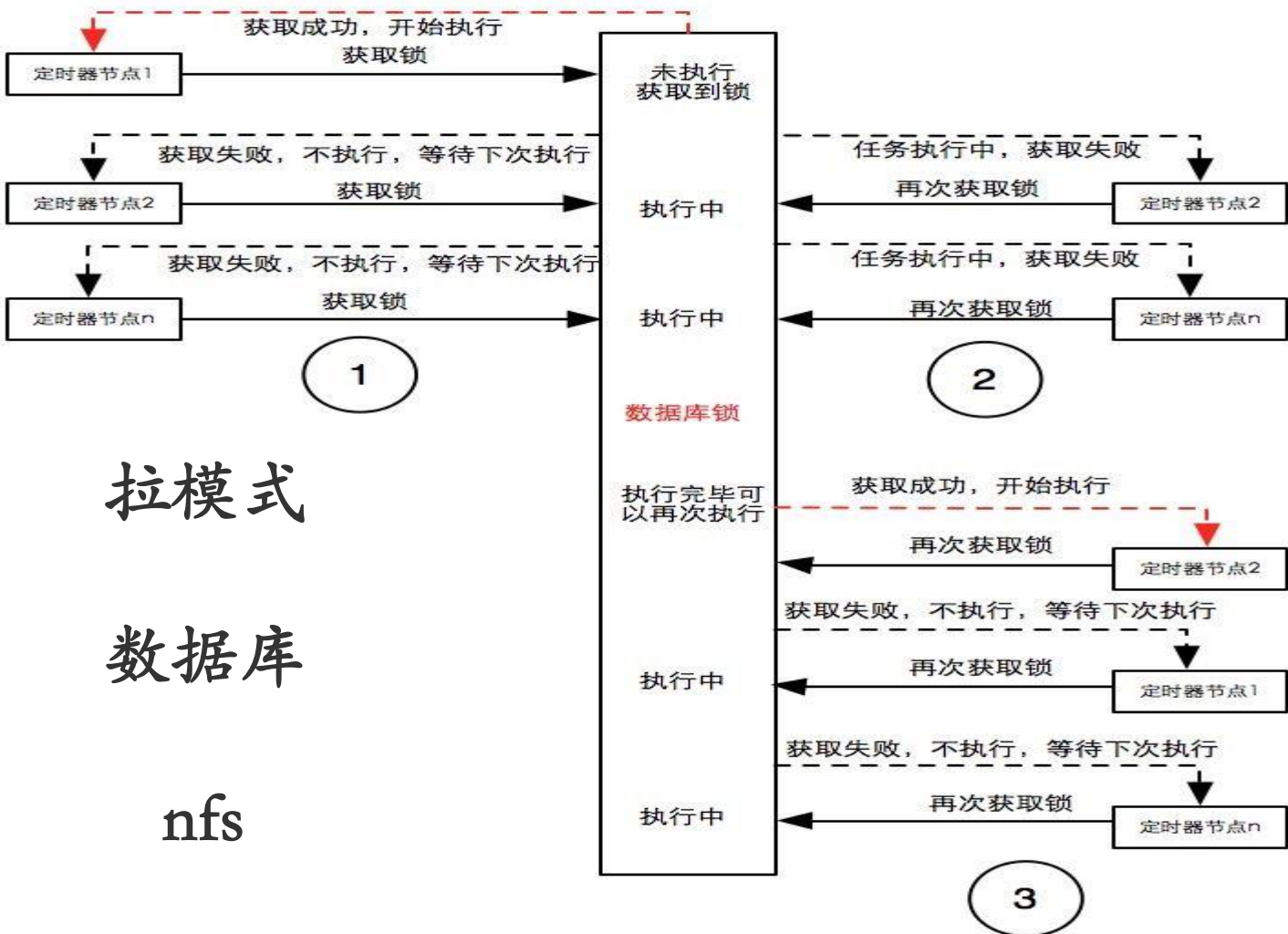

拉模式

数据库

nfs

新增
替代修改

数据
属主原则

并发版本
控制

数据的
规模控制

区分缓存和
内存数据库





科技让金融更简单

谢谢